

OUTDOOR APPROVED

ELECTRIC FIREPLACES WITH A HEATER

Amantii

An Electric Fireplace placed outside not only provides efficient, customizable heating, but can be a stunning focal point in any room.



Symmetry 60" Lumina with Oak Media Electric Fireplace

Manufacturer guidelines regarding outdoor installation must be followed. Please refer to the owner's manual for additional information.

SYMMETRY LUMINA

34" • 42" • 50" • 60" • 74" • 88" • 100"

The Symmetry Lumina Electric Fireplace – where innovation meets ambiance and convenience in one stunning package. Elevate your home's atmosphere with the mesmerizing dance of vibrant flames, now available in three captivating colors. This cutting-edge electric fireplace is designed to not only be a stunning focal point but also a versatile source of warmth and comfort.

Immerse yourself in the beauty of vibrant flames, personalized comfort, and whisper-quiet warmth. This innovative fireplace is the epitome of style and functionality, providing the perfect solution for any season or setting. Elevate your home, embrace the warmth, and enjoy the quiet comfort you deserve.

KEY FEATURES

- Patented Thermostatic Remote Control
- Clear Reduced Trim Kit
- Masonry Finish to Trim Option
- 1465W 5000 BTU, heat up 400 sq ft room
- 50000 Hours Lifetime LED Light Source
- Smart Room Temperature Control 59°F–82°F or 15°C–28°C
- Improved Flame Effect
- Adjustable Flame Brightness
- Adjustable Flame Speed
- Adjustable Ember Bed Colors with possibility to auto mix thousands of colors
- Timer: Regular Timer (1–8 hours) and 7-Day Pre-Set Timer
- Flame and Ember Bed Glow can be on separately
- Whisper quiet heater/fan – “the most quiet fireplace in industry”
- Improved 11 Color Downlight
- Designed with front flow heating with hidden venting so that the unit can be recessed or semi flush mounted
- Slim frame that features a large viewing area with true life like LED flames that cannot be rivaled
- Programmable timer for automatic turn on or off at any set time. Set the fireplace to turn on before you arrive home or have it automatically turn on when the weather is cold.
- Thermostatic remote comes included
- Two unique flame styles – standard or more traditional
- The most reliable components in industry

IDEAL APPLICATIONS:

- Residential spaces
- Commercial spaces
- Restaurants
- New construction or renovations
- Outdoor use; refer to installation manual

TECHNICAL SPECIFICATIONS

Volts	120V
Amps	13
Watts	1465 Watts
Heater On	1465 Watts high, 732 Watts low
Heater Off	60 Watts Max
Rotor Motor	1 at 2.9 Watts
BTU	5000

Hidden venting and no grills. The heater is located at the top of the unit allowing heat to cascade down in front of the glass.



2 YEAR WARRANTY



ORANGE FLAME



YELLOW FLAME



RED FLAME

INCLUDED ACCESSORIES

Models comes with 12PCE Oak MD, decorative glass media, surround, and a remote.



DESIGN-MEDIA-OAK-12PCE-MD

Symmetry 60" Lumina with Birch Media Electric Fireplace



SYMMETRY XT LUMINA

34" • 42" • 50" • 60" • 74" • 88" • 100"

Elevate your living space with the Symmetry XT Lumina Electric Fireplace, a harmonious blend of aesthetics and functionality. Watch as the captivating flames infuse your home with charm, all while enjoying customizable comfort and the quiet warmth you've always desired. Transform your space into a sanctuary of modern elegance with the Symmetry XT Lumina Electric Fireplace. The 74", 88" and 100" Symmetry XT Lumina Electric Fireplaces come with the flexibility to be connected to a 240-volt power source, enhancing the heating capabilities to 10,230 volts of BTU.

KEY FEATURES

- Glass viewing area is 18" tall with no unsightly venting visible
- WiFi compatible to connect and control the fireplace from your smartphone with the use of our app. Available on the Google play store and the Apple App Store.
- Programmable timer & thermostat allows you to decide the temperature of the room. Set the fireplace to turn on before you arrive home or have it automatically turn on when the weather is cold.
- Smart Room Temperature Control - 59°F - 82°F or 15°C - 28°C
- Patented thermostatic remote comes included
- Masonry finish to trim option
- Most quiet and reliable components in the industry
- 1465W 5000 BTU, heats up to 500 Sq. Ft. May also be wired to 240 volts to increase the BTU output to 10,230, heats up to 900 Sq. Ft.
- 50000 hours lifetime LED light source
- Approved for Outdoor Installations*
- Designed with front flow heating and hidden venting so that the unit can be recessed or semi flush mounted.
- A clear reduced trim kit allows for a large viewing area with true lifelike flames that can not be rivaled.
- Adjustable flame brightness and speed that can be turned on separately.
- Adjustable ember bed colors that allow for the possibility of auto mixing thousands of colors

IDEAL APPLICATIONS

- Residential spaces
- Commercial spaces
- Restaurants
- New construction or renovations
- Outdoor use; refer to installation manual

TECHNICAL SPECIFICATIONS

Volts	120V
Amps	13
Watts	1465 Watts
Heater On	1465 Watts high, 732 Watts low
Heater Off	60 Watts Max
Rotor Motor	1 at 2.9 Watts
BTU	5000

Hidden venting and no grills. The heater is located at the top of the unit allowing heat to cascade down in front of the glass.



2 YEAR WARRANTY

INCLUDED ACCESSORIES

Models come with a choice of a Design Media kit - Driftwood, Birch or Rustic, Oak 18PCE, Split, 12PCE Oak, or ICE media

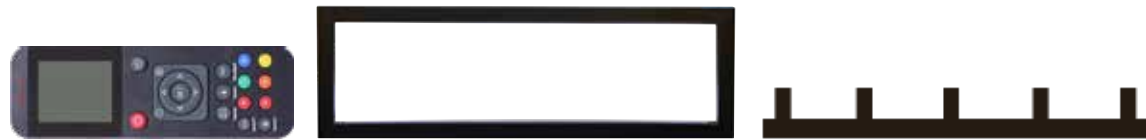

YOUR CHOICE:

			
DESIGN-MEDIA-BIRCH-15PCE	DESIGN-MEDIA-DRIFT-15PCE	DESIGN-MEDIA-RUSTIC-14PCE	ICE-MEDIA-FI-109-DIAMOND
			
DESIGN-MEDIA-SPLIT-LOG-16PCE	DESIGN-MEDIA-OAK-18PCE	DESIGN-MEDIA-OAK-12PCE-LG	

**Manufacturer guidelines regarding outdoor installation must be followed. Please refer to the owner's manual for additional information*

Symmetry 50" XT Lumina with Oak Media Electric Fireplace



SYMMETRY BESPOKE

34" • 42" • 50" • 60" • 74" • 88" • 100"

SYMMETRY BESPOKE SMART IS THE WAY OF THE FUTURE!

Among the things that make our lives beautiful, fireplaces occupy an important position. Our Symmetry Bespoke Smart is more than just an ordinary fireplace, it is a well designed fireplace, unique as it combines classic form with a modern interpretation. With many customizations, all available on the app or remote, flame speed, flame colors, ember bed colors, brightness. Set up the temperature you want the room to be and the heat will turn off once the temperature has been reached. Symmetry Bespoke transforms your space into one of comfort and luxury!

KEY FEATURES

- 5 Year Warranty
- Fire & Sound – Two (2) quality audio speakers deliver a fire crackling sound. The audio is an ON/OFF feature that can be controlled through the WiFi app
- WiFi compatible to connect and control the fireplace from your smartphone with the use of our app. Available on the Google Play Store and the Apple App Store
- Bluetooth Connectivity – Featuring a fireplace with high quality audio from Bluetooth speakers. Simply pair your phone with the fireplace and press play on your smartphone
- Programmable timer & thermostat allows you to decide the temperature of the room. Set the fireplace to turn on before you arrive home or have it automatically turn on when the weather is cold.
- Smart Room Temperature Control 59°F - 82°F or 15°C - 28°
- 1465W – 5000 BTU, heats up to 500 Sq. Ft.
- 50000 hours lifetime LED light source
- Approved for Outdoor Installations*
- Designed with front flow heating and hidden venting so that the unit can be recessed or semi flush mounted
- A clear reduced trim kit allows for a large viewing area with true lifelike flames that cannot be rivaled
- Adjustable flame brightness and speed that can be controlled independently.
- Adjustable ember bed colors that allow for the possibility of auto mixing thousand of colors
- Most quiet and reliable components in the industry
- Patented thermostatic remote comes included
- Masonry finish to trim option

IDEAL APPLICATIONS

- Residential spaces
- Commercial spaces
- Restaurants
- New construction or renovations
- Outdoor use; refer to installation manual

TECHNICAL SPECS

Volts	120
Amps	12.5 A
Watts	1465 max
Heater On	1465 watts high, 732 watts low
Heater Off	21 Watts - SYM 50 Bespoke 31 Watts - SYM 60 Bespoke 36 Watts - SYM 74 Bespoke
Rotor Motor	1 at 2.9 Watts
BTU	5000 Max

Hidden venting and no grills. The heater is located at the top of the unit allowing heat to cascade down in front of the glass.



5 YEAR WARRANTY



ORANGE FLAME



YELLOW FLAME



RED FLAME

INCLUDED ACCESSORIES

Models come with a choice of a Design Media kit - Ice Media, 12PCE Oak MD, or Ember, Clear, Suntea and Harvest Moon Fireglass



YOUR CHOICE:



ICE-MEDIA-FI-109-DIAMOND



DESIGN-MEDIA-OAK-12PCE-MD



EMBER, CLEAR, SUNTEA, AND HARVEST MOON

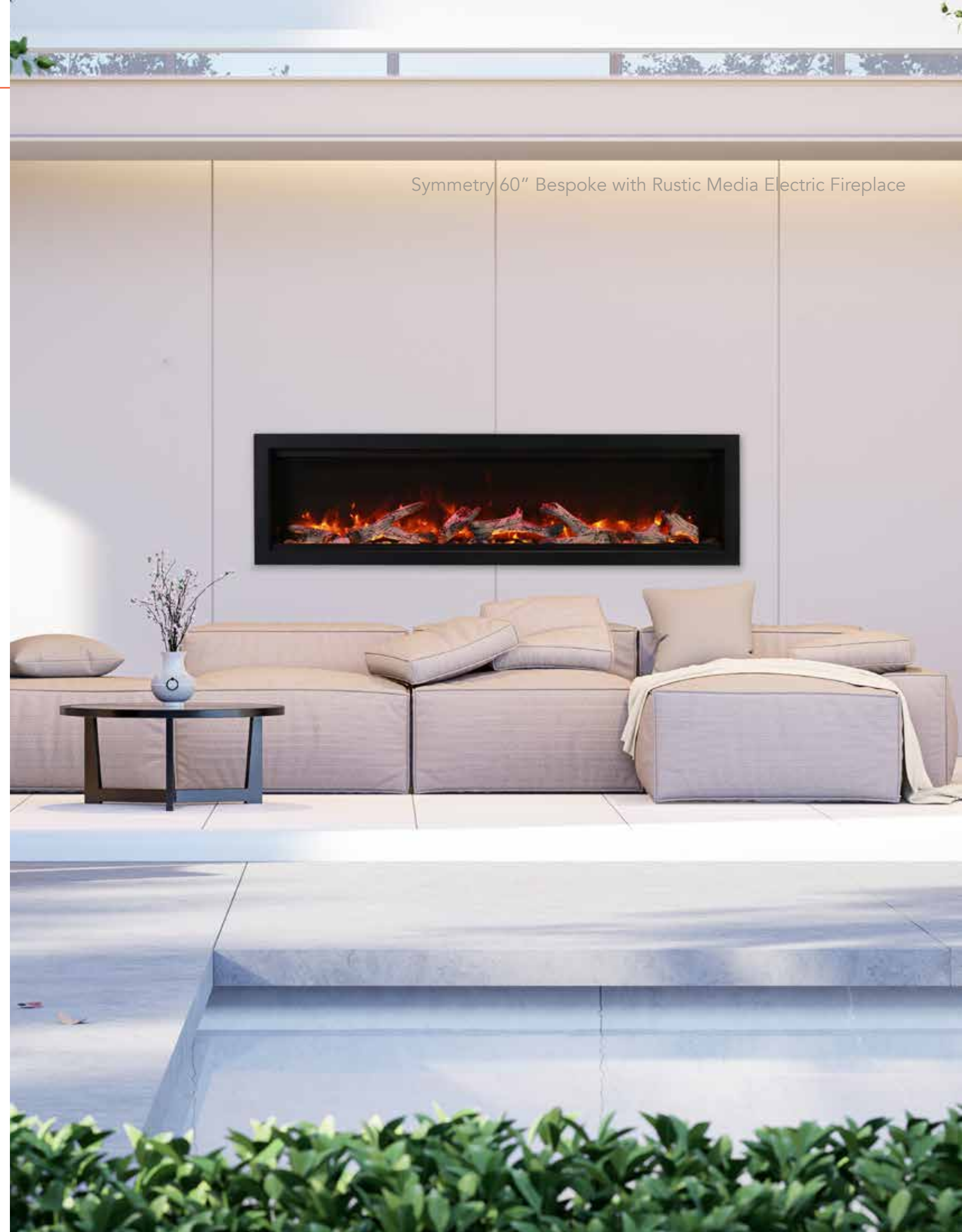

Symmetry 60" Bespoke with Rustic Media Electric Fireplace

SYMMETRY XT BESPOKE

42" • 50" • 60" • 74" • 88" • 100"

The Symmetry Xtra Tall Bespoke Smart is grandly proportioned to fit in great rooms and commercial settings. It's the size and height of this electric fireplace that started it all, revolutionizing the electric fireplace industry. Delivering tall, full flames, it commands presence in any room and can be customized to your taste – from contemporary to traditional, the media log set selection is yours.

Unencumbered by unsightly venting, the Symmetry Xtra Tall Bespoke Smart features a truly clean face display. Standard unit sizing means hassle free installation at any stage, inside or outside. Symmetry Xtra Tall Bespoke Smart is the perfect blend of versatility, style and function.

KEY FEATURES

- 5 Year Warranty
- Fire & Sound – Two (2) quality audio speakers deliver a fire crackling sound. The audio is an ON/OFF feature that can be controlled through the WiFi app.
- WiFi compatible to connect and control the fireplace from your smartphone with the use of our app. Available on the Google play store and the Apple App Store.
- Bluetooth Connectivity – Featuring a fireplace with high quality audio from Bluetooth speakers. Simply pair your phone with the fireplace and press play on your smartphone.
- Programmable timer & thermostat allows you to decide the temperature of the room. Set the fireplace to turn on before you arrive home or have it automatically turn on when the weather is cold.
- Smart Room Temperature Control - 59°F - 82°F or 15°C - 28°C
- 1465W 5000 BTU, heats up to 500 Sq. Ft. May also be wired to 240 volts to increase the BTU output to 10,230, heats up to 900 Sq. Ft.
- 50000 hours lifetime LED light source
- Approved for Outdoor Installations*
- Designed with front flow heating and hidden venting so that the unit can be recessed or semi flush mounted.
- A clear reduced trim kit allows for a large viewing area with true lifelike flames that can not be rivaled.
- Adjustable flame brightness and speed that can be turned on separately.
- Adjustable ember bed colors that allow for the possibility of auto mixing thousands of colors
- Most quiet and reliable components in the industry
- Patented thermostatic remote comes included
- Masonry finish to trim option

IDEAL APPLICATIONS

- Residential spaces
- Commercial spaces
- Restaurants
- New construction or renovations
- Outdoor use; refer to installation manual

TECHNICAL SPECIFICATIONS

Volts	120V OR 240V
Amps	12.5
Watts	1465 or 3000W max
Heater On	1465 Watts high, 732 Watts low
Heater Off	42.7 Watts – SYM 50 XT Bespoke 45.2 Watts – SYM 60 XT Bespoke 60.4 Watts – SYM 74 XT Bespoke
Rotor Motor	1 at 2.9 Watts
BTU	5000 BTU on 120 Volts 10,230 BTU on 240 Volts

Heats up to 500 Sq Feet on 120 Volts
Heats up to 900 Sq Feet on 220 Volts



5 YEAR WARRANTY

Hidden venting and no grills. The heater is located at the top of the unit allowing heat to cascade down in front of the glass.



ORANGE FLAME



YELLOW FLAME



RED FLAME

INCLUDED ACCESSORIES

Models come with a choice of a Design Media kit - Driftwood, Birch or Rustic, Oak 18PCE, Split, 12PCE Oak, or ICE media



YOUR CHOICE:



DESIGN-MEDIA-BIRCH-15PCE



DESIGN-MEDIA-DRIFT-15PCE



DESIGN-MEDIA-RUSTIC-14PCE



ICE-MEDIA-FI-109-DIAMOND



DESIGN-MEDIA-SPLIT-LOG-16PCE



DESIGN-MEDIA-OAK-18PCE



DESIGN-MEDIA-OAK-12PCE-LG

**Manufacturer guidelines regarding outdoor installation must be followed. Please refer to the owner's manual for additional information*



Symmetry 42" XT Bespoke with Split Log Media Electric Fireplace

TRU VIEW BESPOKE

45" • 55" • 65" • 75" • 85"

Introducing the Tru View Bespoke series from Amantii Electric, the ultimate in electric fires, using cutting edge technology and innovation to provide instant heat, realistic flames and adaptive ambiance to your living space.

The Tru View Bespoke is the outstanding result of extensive research and development, meticulous attention to detail, and the highest standard of quality. With a host of innovative features, our electric fires are unrivalled in their class.

A versatile design that can be installed in a multitude of ways; connect multiple units to make a bold statement.

Unlike other fireplaces, the Tru View Bespoke features customizable installation and connectable units for a grand masterpiece. With the fireplace, optional connection pieces come included.

Instant heat at your fingertips.

Part of the Tru View Bespoke design is to ensure that the fireplace offers clear and simple controllability. While functionality may have advanced and become more dynamic, we believe intuitive interaction is paramount.

The Tru View Bespoke can be controlled in three ways:

- Manually using the multi function control panel discretely located on the fireplace.
- With the intuitive remote control
- Through your smart device using WiFi connectivity.

With WiFi connectivity, enhance your experience with our smart app that enables you to control your fireplace from anywhere! The app allows you to set tailored programs, schedule on/off times, set temperatures, design custom light effects and so much more.

ADDITIONAL FEATURES

- Available in sizes 45", 55", 65", 75" and 85"
- Biggest and the Best - 20" Viewing area
- Double the heat output from 5000 to 10,000, when two units are joined together on 120V
- TRV 45 comes with 1 heater fan, Max 5000 BTU on 120V
- The TRV 55, 65, 75 & 85 come with 2 heater fans, Max 5000 BTU on 120V, or 10,000 BTU on 240V
- Electrical & BTU 120V, 1500W, 12.5 A and 5,000 BTU
240V, 2500W, 10.4 A and 10,000 BTU
2 units together 240V, 20,000 BTU

INCLUDED ACCESSORIES



FIREGLASS MEDIA



AMSF-07

AMSF-15



AMSF-16

YOUR CHOICE:



DESIGN-MEDIA-BIRCH-15PCE



DESIGN-MEDIA-DRIFT-15PCE



DESIGN-MEDIA-RUSTIC-14PCE



DESIGN-MEDIA-SPLIT-LOG-16PCE



DESIGN-MEDIA-OAK-18PCE



ICE-MEDIA-FI-109-DIAMOND

KEY FEATURES

- 5 Year Warranty
- Fire & Sound – Two (2) quality audio speakers deliver a fire crackling sound. The audio is an ON/OFF feature that can be controlled through the WiFi app.
- WiFi compatible to connect and control the fireplace from your smartphone with the use of our app. Available on the Google play store and the Apple App Store.
- Bluetooth Connectivity – Featuring a fireplace with high quality audio from Bluetooth speakers. Simply pair your phone with the fireplace and press play on your smartphone.
- Programmable timer & thermostat allows you to decide the temperature of the room. Set the fireplace to turn on before you arrive home or have it automatically turn on when the weather is cold.
- Smart Room Temperature Control - 59°F - 82°F or 15°C - 28°C
- 1465W 5000 BTU, heats up to 500 Sq. Ft. May also be wired up to 220 volts to increase the BTU output to 10,000 and heats up to 800-1,000 Sq. Ft.
- 50000 hours lifetime LED light source
- Approved for Outdoor Installations*
- Designed with front flow heating and hidden venting so that the unit can be recessed or semi flush mounted
- A clean reduced trim kit allows for a large viewing area with true lifelike flames that can not be rivaled.
- Adjustable flame brightness and speed that can be turned on separately.
- Adjustable ember bed colors that allow for the possibility of auto mixing thousands of colors.
- Most quiet and reliable components in the industry
- Patented thermostatic remote comes included
- Masonry finish to trim option

5 YEAR WARRANTY



TRV 55" Bespoke with Birch Media Electric Fireplace

THE COMBINATION POSSIBILITIES ARE ENDLESS

It is possible to make multiple sizes by simply placing two or three units together of any size. A linear fireplace of 90" can be created by joining two 45" Tru View Bespoke units together.

Combine a 55" and 65" Tru View Bespoke for 120". Combining two units of 75" would be a custom 150" electric fireplace. A Tru View Bespoke linear fireplace of 185" would consist of two 55" and one 75" unit.

Anything can be combined, and the possibilities are endless

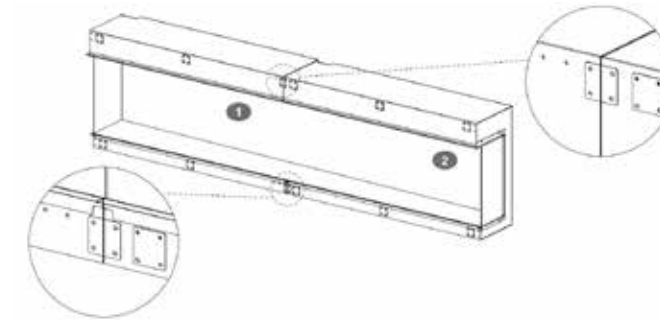

- 45" & 45" for 90"
- 45" & 55" for 100"
- 45" & 65" for 110"
- 45" & 75" for 120"
- 45" & 85" for 130"

- 75" & 45" for 120"
- 75" & 55" for 130"
- 75" & 65" for 140"
- 75" & 75" for 150"
- 75" & 85" for 160"

- 55" & 45" for 100"
- 55" & 55" for 110"
- 55" & 65" for 120"
- 55" & 75" for 130"
- 55" & 85" for 140"

- 85" & 45" for 130"
- 85" & 55" for 140"
- 85" & 65" for 150"
- 85" & 75" for 160"
- 85" & 85" for 170"

- 65" & 45" for 110"
- 65" & 55" for 120"
- 65" & 65" for 130"
- 65" & 75" for 140"
- 65" & 85" for 150"



TRV 45 Bespoke



TRV 55 Bespoke



TRV 65 Bespoke



TRV 75 Bespoke



TRV 85 Bespoke

TRU VIEW SLIM SMART

30" • 40" • 50" • 60" • 72"

Tru View Slim Smart electric fireplaces are designed to fit into a 2" x 4" wall opening size since they have a depth of 4 inches. Available in five sizes, 30", 40", 50", 60" and 72", you'll find a unit that is perfect for any space in your home or commercial space. The Tru View Slim Smart is perfectly suited to installations where wall depth is at a premium.

Boasting high intensity LED flames allowing for multi color flame options, WiFi compatibility, 3 flame speeds and a thermostatic remote control.

The Tru View Slim Smart comes standard with a 10 piece birch log set and charcoal and black fireglass

KEY FEATURES

- 3-sided built-in electric fireplace
- WiFi Compatible to connect and control the fireplace from your smartphone with the use of our app. Available on the Google Play Store and Apple App Store
- Three speed flame motor
- Heat output 5000 BTU
- No unsightly venting and grills seen. A true clean and vent free look
- Programmable timer & thermostat allows you to decide the temperature of the room. Set your fireplace to turn on before you arrive home or have it automatically turn on when the weather is cold.
- Touch pad for convenient control of the features and temperature display from the fireplace.
- Choose from combinations of yellow, orange and red colored flames
- Approved for indoor or outdoor applications.*
- Choose from 11 colors of canopy and ember bed lighting to illuminate decorative media from below and above
- Two flame pattern styles – standard and more traditional
- New patented thermostatic remote comes included

IDEAL APPLICATIONS

- Apartments
- New construction or renovations
- Outdoor spaces

TECHNICAL SPECS

Volts	120
Amps	12.5
Watts	1465 max
Heater On	1465 W high, 750 W low
Heater Off	25 W
Rotor Motor	1 at 5 W
BTU	5000



2 YEAR WARRANTY



ORANGE FLAME



YELLOW FLAME



RED FLAME

INCLUDED ACCESSORIES

Models come with a 10 piece log set and Charcoal grey fire glass, vermiculite, black fire glass plus a remote.



TRV 75" with Rustic Media Electric Fireplace



TRU VIEW XL DEEP SMART

40" • 50" • 60" • 72"

Infused with the timeless beauty of fireplaces, the Tru View XL Deep Smart brings it to the modern age. Three sided, two sided, or front facing installation is possible with the included end panels and edge to edge 3-sided glass.

This visually stunning fireplace is available in 4 sizes, 40", 50", 60", and 72", and will turn heads while adding warmth, ambiance, and style to any room. Designed for finishing material to be built flush to the lip for a truly clean, edge to edge finish. No trim or surround is included.

The Tru View XL Deep Smart series includes your choice of Design Media Log Sets- 15 Piece Driftwood, 14 Piece Rustic, 15 Piece Birch, 16 Piece Split Log and the Ice Media Kit

KEY FEATURES

- 3-sided built-in electric fireplace
- WiFi Compatible to connect and control the fireplace from your smartphone with the use of our app. Available on the Google Play Store and Apple App Store
- Three speed flame motor
- Heat output 5000 BTU
- No unsightly venting and grills seen. A true clean and vent free look
- Programmable timer & thermostat allows you to decide the temperature of the room. Set your fireplace to turn on before you arrive home or have it automatically turn on when the weather is cold.
- Touch pad for convenient control of the features and temperature display from the fireplace.
- Choose from combinations of yellow, orange and red colored flames
- Approved for indoor or outdoor applications.*
- Choose from 11 colors of canopy and ember bed lighting to illuminate decorative media from below and above
- Two flame pattern styles – standard and more traditional
- New patented thermostatic remote comes included

IDEAL APPLICATIONS

- Residential spaces
- Patios
- Outdoor spaces
- Commercial spaces
- Restaurants
- New construction or renovations

TECHNICAL SPECS

Volts	120
Amps	12.5
Watts	1465 max
Heater On	1465 W high, 750 W low
Heater Off	25 W
Rotor Motor	1 at 5 W
BTU	5000



2 YEAR WARRANTY

INCLUDED MEDIA OPTIONS

Models come with a choice of a Design Media kit - Driftwood, Birch or Rustic, Oak 18PCE, Split, 12PCE Oak, or ICE media



YOUR CHOICE:



DESIGN-MEDIA-BIRCH-15PCE



DESIGN-MEDIA-DRIFT-15PCE



DESIGN-MEDIA-RUSTIC-14PCE



DESIGN-MEDIA-SPLIT-LOG-16PCE



DESIGN-MEDIA-OAK-18PCE



ICE-MEDIA-FI-109-DIAMOND



TRU VIEW XL EXTRA TALL SMART

40" • 50" • 60" • 72"

Introducing flames into your living space can not be easier with our stunning Tru View XL Extra Tall Smart Fireplaces. With the Tru View XL Extra Tall series, you'll find a selection of logs, embers, and glass media to create the stunning illusion of flames.

This unit can be built-in to a wall as a single sided, left corner, right corner, or three sided bay. Using this versatility, you can create some truly unique installations for standard rooms or rooms with unusual configurations.

With 22" in glass viewing height you'll enjoy unobstructed viewing of the high intensity LED flame effects. Our Tru View XL Extra Tall Smart is truly a showstopper.

KEY FEATURES

- 3-sided built-in electric fireplace
- WiFi Compatible to connect and control the fireplace from your smartphone with the use of our app. Available on the Google Play Store and Apple App Store
- Three speed flame motor
- Heat output 5000 BTU
- No unsightly venting and grills seen. A true clean and vent free look
- Programmable timer & thermostat allows you to decide the temperature of the room. Set your fireplace to turn on before you arrive home or have it automatically turn on when the weather is cold.
- Touch pad for convenient control of the features and temperature display from the fireplace.
- Choose from combinations of yellow, orange and red colored flames
- Approved for indoor or outdoor applications.*
- Choose from 11 colors of canopy and ember bed lighting to illuminate decorative media from below and above
- Two flame pattern styles – standard and more traditional
- New patented thermostatic remote comes included

IDEAL APPLICATIONS

- Residential spaces
- Patios
- Outdoor spaces
- Commercial spaces
- Restaurants
- New construction or renovations

TECHNICAL SPECS

Volts	120
Amps	12.5
Watts	1465 max
Heater On	1465 W high, 750 W low
Heater Off	25 W
Rotor Motor	2 at 5 W
BTU	5000



2 YEAR WARRANTY

INCLUDED MEDIA OPTIONS

Models come with a choice of a Design Media kit - Driftwood, Birch or Rustic, Oak 18PCE, Split, 12PCE Oak, or ICE media



YOUR CHOICE:



DESIGN-MEDIA-BIRCH-15PCE



DESIGN-MEDIA-DRIFT-15PCE



DESIGN-MEDIA-RUSTIC-14PCE



DESIGN-MEDIA-SPLIT-LOG-16PCE



DESIGN-MEDIA-OAK-18PCE



ICE-MEDIA-FI-109-DIAMOND



THE CUBE SMART

The Cube 2025WM Smart 3-Sided electric fireplace offers an innovative fire feature with unique flame presentation and fire media options.

Use the included remote to combine the flame presentation colors of red, yellow and orange to your home with the help of today's technology and high definition LED accent lighting.

The 5000 BTU heater warms up to 500 Square Feet of space while the flames operate independently of the heater and fan. This versatile unit can be configured with a pedestal base, or as a wall mount depending on your preference. Give your home a more contemporary atmosphere with this beautiful electric fireplace.

KEY FEATURES

- 3-sided built-in electric fireplace
- WiFi Compatible to connect and control the fireplace from your smartphone with the use of our app. Available on the Google Play Store and Apple App Store
- Three speed flame motor
- Heat output 5000 BTU
- No unsightly venting and grills seen. A true clean and vent free look
- Programmable timer & thermostat allows you to decide the temperature of the room. Set your fireplace to turn on before you arrive home or have it automatically turn on when the weather is cold.
- Touch pad for convenient control of the features and temperature display from the fireplace.
- Choose from combinations of yellow, orange and red colored flames
- Approved for indoor or outdoor applications.*
- Choose from 11 colors of canopy and ember bed lighting to illuminate decorative media from below and above
- Two flame pattern styles – standard and more traditional
- New patented thermostatic remote comes included

IDEAL APPLICATIONS

- Residential spaces
- Patios
- Outdoor spaces
- Commercial spaces
- Restaurants
- New construction or renovations

TECHNICAL SPECS

Volts	120
Amps	12.5
Watts	1465 max
Heater On	1465 W high, 750 W low
Heater Off	25 W
Rotor Motor	1 at 5 W
BTU	5000



2 YEAR WARRANTY

CUBE 2025WM Smart Speaker Base Dimensions
*Height, Width, Depth: 17 3/4 x 19 5/8 x 11 3/4

*Manufacturer guidelines regarding outdoor installation must be followed. Please refer to the owner's manual for additional information



Leg Base Dimensions
*Height, Width, Depth: 7x 20 1/2 x 12 5/8



Leg Base is not approved for use outdoors.

INCLUDED ACCESSORIES

Models come with a 10 piece log set and Charcoal grey fire glass, vermiculite, black fire glass plus a remote.



MEASUREMENTS

Nº 1. Cube with Speaker Base
43" x 19 5/8" x 11 3/4"

Nº 3. Cube Wall Mount
25 1/4" x 19 5/8" x 11 3/4"

Nº 2. Cube with Leg Base
33 5/8" x 19 5/8" x 11 3/4"

Nº 4. Leg Base
8 3/8" x 20 1/2" x 12 5/8"



Cube with Birch Media Electric Fireplace

TRADITIONAL LUMINA

26" • 30" • 33" • 38" • 44" • 48"

The TRADITIONAL LUMINA Electric Fireplace is the perfect fusion of classic charm and contemporary technology. This new product series brings the timeless appeal of a traditional fireplace and infuses it with the innovation and convenience of electric heating. With its elegant design, realistic flame effects, and customizable features, the TRADITIONAL LUMINA series evokes a sense of nostalgia while providing modern comfort.

Crafted to seamlessly blend with various interior styles, these electric fireplaces offer the warmth and ambiance of a real fire without the hassles of maintenance or venting.

KEY FEATURES

- 2 Year Warranty
- WiFi compatible to connect and control the fireplace from your smartphone with the use of our app. Available on the Google play store and the Apple App Store.
- Programmable timer & thermostat allows you to decide the temperature of the room. Set the fireplace to turn on before you arrive home or have it automatically turn on when the weather is cold.
- Smart Room Temperature Control - 59°F - 82°F or 15°C - 28°C
- 1465W 5000 BTU, heats up to 500 Sq. Ft.
- 50000 hours lifetime LED light source
- Smart Room Temperature Control - 59°F - 82°F or 15°C - 28°C
- 1465W 5000 BTU, heats up to 500 Sq. Ft.
- Approved for Outdoor Installations*
- Designed with front flow heating and hidden venting so that the unit can be recessed or semi flush mounted
- A clean reduced trim kit allows for a large viewing area with true lifelike flames that can not be rivaled.
- Adjustable flame brightness and speed that can be turned on separately.
- Adjustable ember bed colors that allow for the possibility of auto mixing thousands of colors.
- Most quiet and reliable components in the industry
- Patented thermostatic remote comes included
- Masonry finish to trim option or Insert surround option

TECHNICAL SPECIFICATIONS

Volts	120V
Amps	12.5 A
Watts	1465 Watts
Heater On	1465 Watts high, 732 Watts low
Heater Off	27 Watts – TRD 33 Lumina 32.6 Watts – TRD 38 Lumina 37.8 Watts – TRD 44 Lumina
Rotor Motor	1 at 2.9 Watts
BTU	5000

SERIES MODELS:

- TRD-26-LUMINA
- TRD-30-LUMINA
- TRD-33-LUMINA
- TRD-38-LUMINA
- TRD-44-LUMINA
- TRD-48-LUMINA



2 YEAR WARRANTY



26" 30" WILL BE AVAILABLE MID 2024



ORANGE FLAME



YELLOW FLAME



RED FLAME

INCLUDED ACCESSORIES

Models come with Design Media Oak LG 12PCE, trim, 2 small bags of vermiculite, clear fireglass, remote and grate

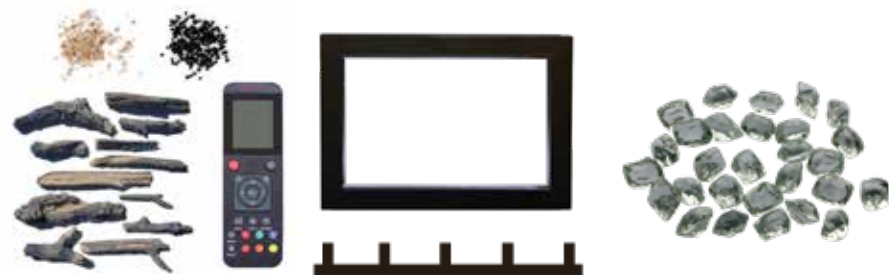

TRD 33" Lumina with Birch Media Electric Fireplace

TRADITIONAL BESPOKE

30" • 33" • 38" • 44" • 48"

Using the latest technology, Traditional Bespoke Smart presents a new interpretation of the classic fireplace with quality and style. Select flame colors, sound, heat and so much more by pairing your phone with the fireplace and press play on your smartphone. Heater vents are concealed in the upper top of the unit, enabling a truly clean face appearance.

Enjoy the brilliant flames of this fireplace even while the heat is off for ambiance during every season.

With this timeless fireplace, you will be able to breathe new life into any room while adding warmth and ambiance,

KEY FEATURES

- 5 Year Warranty
- Fire & Sound – Two (2) quality audio speakers deliver a fire crackling sound. The audio is an ON/OFF feature that can be controlled through the WiFi app.
- WiFi compatible to connect and control the fireplace from your smartphone with the use of our app. Available on the Google play store and the Apple App Store.
- Bluetooth Connectivity – Featuring a fireplace with high quality audio from Bluetooth speakers. Simply pair your phone with the fireplace and press play on your smartphone.
- Programmable timer & thermostat allows you to decide the temperature of the room. Set the fireplace to turn on before you arrive home or have it automatically turn on when the weather is cold.
- Smart Room Temperature Control - 59°F - 82°F or 15°C - 28°C
- 1465W 5000 BTU, heats up to 500 Sq. Ft.
- 50000 hours lifetime LED light source
- Approved for Outdoor Installations*
- Designed with front flow heating and hidden venting so that the unit can be recessed or semi flush mounted
- A clean reduced trim kit allows for a large viewing area with true lifelike flames that can not be rivaled.
- Adjustable flame brightness and speed that can be controlled independently.
- Adjustable ember bed colors that allow for the possibility of auto mixing thousands of colors.
- Most quiet and reliable components in the industry
- Patented thermostatic remote comes included
- Masonry finish to trim option

TECHNICAL SPECIFICATIONS

Volts	120V
Amps	12.5 A
Watts	1465 Watts
Heater On	1465 Watts high, 732 Watts low
Heater Off	27 Watts – TRD 33 Bespoke 32.6 Watts – TRD 38 Bespoke 37.8 Watts – TRD 44 Bespoke
Rotor Motor	1 at 2.9 Watts
BTU	5000

SERIES MODELS:

- TRD-30 BESPOKE
- TRD-33 BESPOKE
- TRD-38 BESPOKE
- TRD-44 BESPOKE
- TRD-48 BESPOKE



5 YEAR WARRANTY

INCLUDED ACCESSORIES

Models come with a choice of a Design Media kit - Driftwood, Birch or Rustic, Oak 18PCE, Split, 12PCE Oak, or ICE media





DESIGN-MEDIA-BIRCH-15PCE



DESIGN-MEDIA-DRIFT-15PCE



DESIGN-MEDIA-RUSTIC-14PCE



ICE-MEDIA-FI-109-DIAMOND



DESIGN-MEDIA-SPLIT-LOG-16PCE



DESIGN-MEDIA-OAK-18PCE



DESIGN-MEDIA-OAK-12PCE-LG

**Manufacturer guidelines regarding outdoor installation must be followed. Please refer to the owner's manual for additional information*



TRD 38" Bespoke with Oak Media Electric Fireplace

TRADITIONAL LUMINA INSERTS

26" • 30" • 33" • 38"

KEY FEATURES

- 2 Year Warranty
- WiFi compatible to connect and control the fireplace from your smartphone with the use of our app. Available on the Google play store and the Apple App Store.
- Programmable timer & thermostat allows you to decide the temperature of the room. Set the fireplace to turn on before you arrive home or have it automatically turn on when the weather is cold.
- Smart Room Temperature Control - 59°F - 82°F or 15°C - 28°C
- TRD three or four sided surround required for semi flush mounted applications
- Can be fully recessed or semi flush mounted.
- 1465W 5120 BTU, heats up to 500 Sq. Ft
- 50000 hours lifetime LED light source
- Approved for Outdoor Installations*
- Designed with front flow heating and hidden venting so that the unit can be recessed or semi flush mounted.
- A clean reduced trim kit allows for a large viewing area with true lifelike flames that can not be rivaled.
- Adjustable flame brightness and speed that can be turned on separately.
- Adjustable ember bed colors that allow for the possibility of auto mixing thousands of colors.
- Most quiet and reliable components in the industry
- Patented thermostatic remote comes included
- Masonry finish to trim option or Insert surround option

TECHNICAL SPECIFICATIONS

Volts	120V
Amps	10
Watts	1465 Watts
Heater On	1465 Watts high, 732 Watts low
Heater Off	22 Watts
Rotor Motor	1 at 5 Watts
BTU	5000



2 YEAR WARRANTY

TRD 26-Lumina

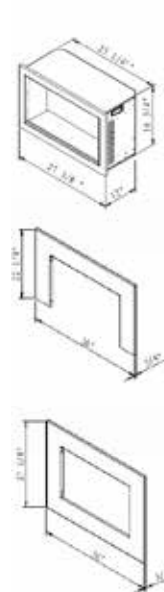

TRD 30-Lumina

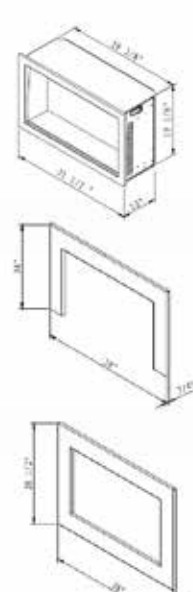

TRD 33-Lumina

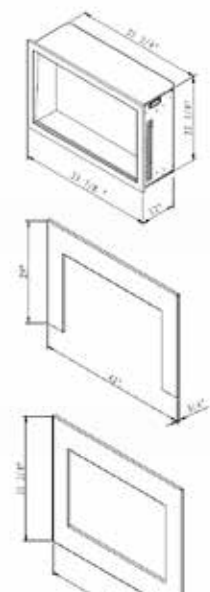

TRD 38-Lumina

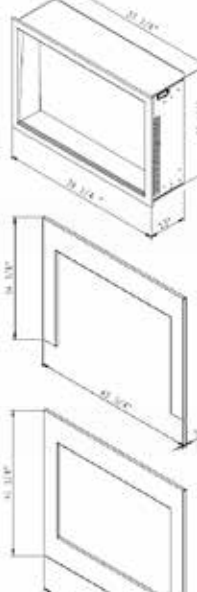

INCLUDED ACCESSORIES

Models come with Design Media Oak LG 12PCE, 2 small bags of vermiculite, clear fireglass, remote and grate



DESIGN-MEDIA-OAK-12PCE-LG

Surrounds Optional:



3-Sided Surround

4-Sided Surround



TRD 33" Lumina Insert with Oak Media Electric Fireplace

TRADITIONAL BESPOKE INSERTS

30" • 33" • 38"

KEY FEATURES

- 5 Year Warranty
- Fire & Sound – Two (2) quality audio speakers deliver a fire crackling sound. The audio is an ON/OFF feature that can be controlled through the WiFi app.
- WiFi compatible to connect and control the fireplace from your smartphone with the use of our app. Available on the Google play store and the Apple App Store.
- Bluetooth Connectivity – Featuring a fireplace with high quality audio from Bluetooth speakers. Simply pair your phone with the fireplace and press play on your smartphone. 🎧
- Programmable timer & thermostat allows you to decide the temperature of the room. Set the fireplace to turn on before you arrive home or have it automatically turn on when the weather is cold.
- 1465W 5120 BTU, heats up to 500 Sq. Ft
- 50000 hours lifetime LED light source
- Approved for Outdoor Installations*
- Designed with front flow heating and hidden venting so that the unit can be recessed or semi flush mounted.
- A clean reduced trim kit allows for a large viewing area with true lifelike flames that can not be rivaled.
- Adjustable flame brightness and speed that can be turned on separately.
- Adjustable ember bed colors that allow for the possibility of auto mixing thousands of colors.
- Most quiet and reliable components in the industry
- Patented thermostatic remote comes included
- Masonry finish to trim option
- Smart Room Temperature Control - 59°F - 82°F or 15°C - 28°C

TECHNICAL SPECIFICATIONS

Volts	120V
Amps	12.5
Watts	1465 Watts
Heater On	1465 Watts high, 732 Watts low
Heater Off	27 W – TRD 33 Bespoke Insert 32.6 W – TRD 38 Bespoke Insert
Rotor Motor BTU	1 at 2.9 Watts 5120

SERIES MODELS:

- TRD-30 BESPOKE Insert
- TRD-33 BESPOKE Insert
- TRD-38 BESPOKE Insert



5 YEAR WARRANTY



ORANGE FLAME



YELLOW FLAME



RED FLAME



TRD-33 BESPOKE Insert



TRD-38 BESPOKE Insert

TRD-33 BESPOKE Insert

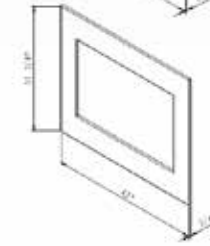
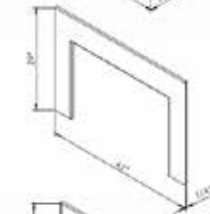
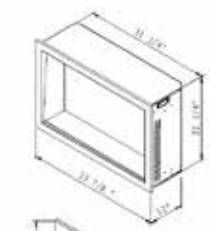

TRD-38 BESPOKE Insert

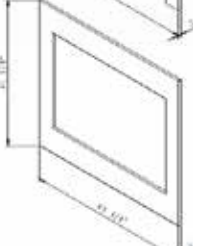
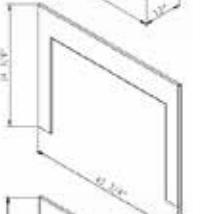
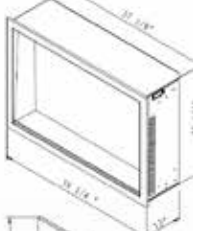

INCLUDED ACCESSORIES

All fireplaces come with a choice of one Designer Media Kit - Driftwood, Rustic, Birch, Split Log, 18Pce Oak, 12PCE Oak or Ice Media. Remote Control comes included.



Surrounds Optional:



3-Sided Surround



4-Sided Surround

YOUR CHOICE:



DESIGN-MEDIA-BIRCH-15PCE



DESIGN-MEDIA-DRIFT-15PCE



DESIGN-MEDIA-RUSTIC-14PCE



ICE-MEDIA-FI-109-DIAMOND



DESIGN-MEDIA-SPLIT-LOG-16PCE



DESIGN-MEDIA-OAK-18PCE



DESIGN-MEDIA-OAK-12PCE-LG

**Manufacturer guidelines regarding outdoor installation must be followed. Please refer to the owner's manual for additional information*



TRD 30" Lumina Insert with Rustic Media Electric Fireplace

BI XTRASLIM SMART

30" • 40" • 50" • 60"

The Panorama Xtraslim Smart fireplace makes a stunning addition to any space - indoor or outdoor - available in 30", 40", 50" and 60" with a 4" depth, you will find a fireplace that is perfect for any space in your home, business, or commercial space.

KEY FEATURES

- WiFi Compatible to connect and control the fireplace from your smartphone with the use of our app. Available on the Google Play Store and Apple App Store
- Three speed flame motor
- Heat output 5000 BTU
- No unsightly venting and grills seen. A true clean and vent free look
- Programmable timer & thermostat allows you to decide the temperature of the room. Set your fireplace to turn on before you arrive home or have it automatically turn on when the weather is cold.
- Touch pad for convenient control of the features and temperature display from the fireplace.
- Choose from combinations of yellow, orange and red colored flames
- Approved for indoor or outdoor applications*
- Choose from 11 colors of canopy and ember bed lighting to illuminate decorative media from below and above
- Two flame pattern styles – standard and more traditional
- New patented thermostatic remote comes included

IDEAL APPLICATIONS

- Residential spaces
- Patios
- Outdoor spaces
- Commercial spaces
- Restaurants
- New construction or renovations

TECHNICAL SPECS

Volts	120
Amps	12.6
Watts	1465 Max
Heater On	1465 W high 750 W low
Heater Off	25 W
Rotor Motor	1 at 5 W
BTU	5000

2 YEAR WARRANTY



INCLUDED ACCESSORIES



OPTIONAL LOG SET



BI-40-XTRASLIM MANTEL SURROUND



Beautifully Inspired

Our mantel surrounds bring the beauty of genuine birch wood into any space. With four nature inspired colors to choose from, you will find a mantel-surround that is perfect for any space in your home, business or commercial setting. Amantii has designed a mantel-surround for your Bi-40-XTRASLIM fireplace that will compliment every style.

All our mantel-surrounds have been crafted from birch wood with a paint wash application reflective of the variety of colors found in a birch tree forest.

As with all genuine products, variations to the natural wood grain will mean there could be slight variations that may differ from the catalog images or samples.

Variations will occur in color, character, tone and grain from product to product. Slight variations between samples and finished goods should be anticipated. In addition, a touch up pen has been included in the packaging should there be any imperfections caused by the shipping of this product.

The BI-40-XTRASLIM mantel-surrounds have been approved for use in kitchens and bathrooms. The mantel-surrounds cannot be used in outdoor settings.

White Birch • Grey Bark • Natural Birch • Knotty Black

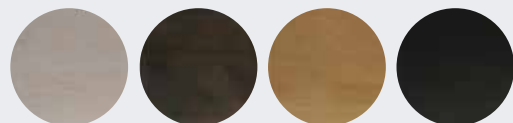

BI 50" XS with Glass Media Electric Fireplace

BI SLIM SMART

40" • 50" • 60" • 72" • 88"

The Panorama Slim Smart series of built-in electric fires have been designed to give you the maximum in flexibility in selecting a unit that perfectly suits your needs.

This stylish fireplace will be a focal point in any room, indoor or outdoor. At just 6 3/4" in depth the Panorama Slim Smart is a practical choice for new construction projects and renovations alike.

The Slim Smart series can be installed with your choice of finishing material right up to the glass for edge to edge viewing, or you can use the black trim that is provided. Additional media options available for purchase.

KEY FEATURES

- WiFi Compatible to connect and control the fireplace from your smartphone with the use of our app. Available on the Google Play Store and Apple App Store
- Three speed flame motor
- 6 3/4" depth. Heat output 5000 BTU
- No unsightly venting and grills seen. A true clean and vent free look
- Programmable timer & thermostat allows you to decide the temperature of the room. Set your fireplace to turn on before you arrive home or have it automatically turn on when the weather is cold.
- Touch pad for convenient control of the features and temperature display from the fireplace.
- Choose from combinations of yellow, orange and red colored flames
- Approved for indoor or outdoor applications.*
- Choose from 11 colors of canopy and ember bed lighting to illuminate decorative media from below and above
- Two flame pattern styles – standard and more traditional
- New patented thermostatic remote comes included

IDEAL APPLICATIONS

- Residential spaces
- Patios
- Outdoor spaces
- Commercial spaces
- Restaurants
- New construction or renovations

TECHNICAL SPECS

Volts	120
Amps	12.5
Watts	1465 max
Heater On	1465 W high 750 W low
Heater Off	25 W
Rotor Motor	1 at 5 W
BTU	5000



2 YEAR WARRANTY



ORANGE FLAME



YELLOW FLAME



RED FLAME

INCLUDED ACCESSORIES

The Panorama Slim series come with clear decorative media and our ICE media kit including large glass chunks, clear and blue diamond media and optional black steel surround, plus a remote.



BI 40" Slim with Glass Chunk Media Electric Fireplace

BI DEEP SMART

40" • 50" • 60" • 72" • 88"

The stunning Panorama BI-Deep Smart series will add a touch of elegance and sophistication to any room. This innovative fire is skillfully engineered to allow a truly trimless fire.

Meticulous attention has been paid to the realization of the ember bed and flame pattern to ensure a perfect recreation of a natural fire.

The Deep Smart series gives you a 12" depth and multiple length options, as well as giving you the ability to install your fireplace with your choice of finishing material built right up to the glass for edge to edge viewing or the using the provided black metal trim. Your choice - your design!

KEY FEATURES

- WiFi Compatible to connect and control the fireplace from your smartphone with the use of our app. Available on the Google Play Store and Apple App Store
- Three speed flame motor
- 12" depth. Heat output 5000 BTU
- No unsightly venting and grills seen. A true clean and vent free look
- Programmable timer & thermostat allows you to decide the temperature of the room. Set your fireplace to turn on before you arrive home or have it automatically turn on when the weather is cold.
- Touch pad for convenient control of the features and temperature display from the fireplace.
- Choose from combinations of yellow, orange and red colored flames
- Approved for indoor or outdoor applications.*
- Choose from 11 colors of canopy and ember bed lighting to illuminate decorative media from below and above
- Two flame pattern styles – standard and more traditional
- New patented thermostatic remote comes included

IDEAL APPLICATIONS

- Residential spaces
- Patios
- Outdoor spaces
- Commercial spaces
- Restaurants
- New construction or renovations

TECHNICAL SPECS

Volts	120
Amps	12.5
Watts	1465 max
Heater On	1465 W high 750 W low
Heater Off	25 W
Rotor Motor	2 at 5 W
BTU	5000



2 YEAR WARRANTY



ORANGE FLAME



YELLOW FLAME



RED FLAME

INCLUDED ACCESSORIES

The Panorama DEEP series come with a 10 piece Oak log set and optional black steel surround, plus a remote.

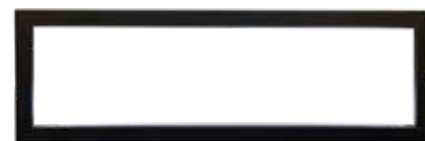

BI 60" Deep with Birch Media Electric Fireplace

BI XTRA TALL SMART

40" • 50" • 60" • 72" • 88"

Featuring an extra viewing area of 18 inches, the Panorama Extra Tall Smart units make a impact in there own right.

The Panorama Extra Tall Smart has a deep media tray and comes with your choice of an incredible media kit that including logs, glass nuggets, pebbles, stones, vermiculite and embers, allowing consumers to completely customize the look of their fireplace.

With just a click of the included remote control, choose from red, yellow or orange flames. Additional features include WiFi connectivity, 3 speed motor, 7 day programmable thermostat, and a energy efficient heater warms up to 400 square feet of space.

KEY FEATURES

- WiFi Compatible to connect and control the fireplace from your smartphone with the use of our app. Available on the Google Play Store and Apple App Store
- Three speed flame motor
- 12" depth. Heat output 5000 BTU
- No unsightly venting and grills seen. A true clean and vent free look
- Programmable timer & thermostat allows you to decide the temperature of the room. Set your fireplace to turn on before you arrive home or have it automatically turn on when the weather is cold.
- Touch pad for convenient control of the features and temperature display from the fireplace.
- Choose from combinations of yellow, orange and red colored flames
- Approved for indoor or outdoor applications.*
- Choose from 11 colors of canopy and ember bed lighting to illuminate decorative media from below and above
- Two flame pattern styles – standard and more traditional
- New patented thermostatic remote comes included

- Residential spaces
- Patios
- Outdoor spaces
- Commercial spaces
- Restaurants
- New construction or renovations

TECHNICAL SPECS

Volts	120
Amps	12.5
Watts	1465 max
Heater On	1465 W high 750 W low
Heater Off	25 W
Rotor Motor	2 at 5 W
BTU	5000



2 YEAR WARRANTY

INCLUDED ACCESSORIES

The Panorama Extra Tall Smart series comes with your choice of one Design Media Kit, the ICE media set, plus a remote.



YOUR CHOICE:

			
DESIGN-MEDIA-BIRCH-15PCE	DESIGN-MEDIA-DRIFT-15PCE	DESIGN-MEDIA-RUSTIC-14PCE	ICE-MEDIA-FI-109-DIAMOND
			
DESIGN-MEDIA-SPLIT-LOG-16PCE	DESIGN-MEDIA-OAK-18PCE	DESIGN-MEDIA-OAK-12PCE-LG	

**Manufacturer guidelines regarding outdoor installation must be followed. Please refer to the owner's manual for additional information*



BI 72" XT with Glass Chunk Media Electric Fireplace

OUTDOOR APPROVED | ELECTRIC FIREPLACES

FIRE GLASS

Our decorative fire glass media is a beautiful addition to your fireplace. Turn your fireplace into a expressive work of art by simply adding our decorative fire glass media. Our fire glass adds a distinctly modern feel to your electric fireplace - mix colors and textures for a unique appearance.

Our decorative fire glass is tempered and will not melt or degrade, some discoloration is normal on glass that is placed directly on the flame. Always wear protective gloves when handling fire glass media.

One 5lb container of media will cover 1 square foot.

AMSF-GLASS-01 AMSF-GLASS-02 AMSF-GLASS-03 AMSF-GLASS-04 AMSF-GLASS-05 AMSF-GLASS-06



AMSF-GLASS-07 AMSF-GLASS-08 AMSF-GLASS-09 AMSF-GLASS-10 AMSF-GLASS-11 AMSF-GLASS-12



AMSF-GLASS-13 AMSF-GLASS-14 AMSF-GLASS-15 AMSF-GLASS-16 FI-105-DIAMOND

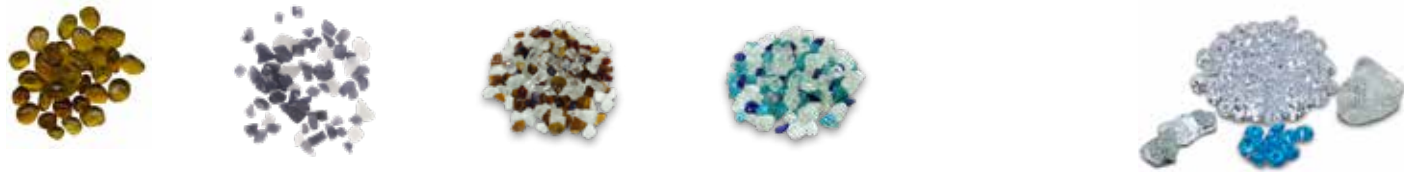

FI-107-DIAMOND FI-109 DIAMOND CLEAR



FIRE & ICE FLAME KIT FIRE & ICE TRAY KIT

This kit provides the necessary components to enable the FIRE & ICE presentation to be included with the Amantii Smart Fireplace. The Smart models use the latest cutting edge technology and innovation to provide instant heat, realistic flame and adaptive lighting. Fire and Ice Flame and Tray Kits are available for purchase.



Images are not to scale, please visit your local dealer to view the actual accessories.

Variations in the color and shade are inherent in all printing processes, the actual colors may vary slightly from those shown.

Note: Log sets and Designer Media Kits will fit in all sizes of the following models - Panorama DEEP, TRU VIEW XL and CUBE ONLY. (Depending on the size of the fireplace model, some logs may not be needed.)

DESIGNER MEDIA KITS

Add incredible value with designer media kits including deluxe log sets, glass and stone media and decorative embers.

DESIGN-MEDIA-BIRCH-10PCE



DESIGN-MEDIA-OAK-10PCE



DESIGN-MEDIA-NATURAL-8PCE



DESIGN-MEDIA-14PCE



Black fire glass 90-piece pebble Rocks



DESIGN-MEDIA-BIRCH-15PCE



Black fire glass 90-piece pebble Rocks



DESIGN-MEDIA-15PCE



Black fire glass Embers 1 Embers 3



DESIGN-MEDIA-6PCE



Black fire glass 90-piece pebble Rocks



DESIGN-MEDIA-SPLIT-LOG-16PCE



Black fire glass 90-piece pebble Rocks



DESIGN-MEDIA-OAK-18PCE



Black fire glass 90-piece pebble Rocks



DESIGN-MEDIA-BIRCH-12PCE



For XT & XT Bespoke models only

The Design Media Birch 12 piece log set expands the Design Media Birch 15 piece log set, if required, and is available for purchase.

DESIGN-MEDIA-OAK-14PCE-XS



DESIGN-MEDIA-OAK-12PCE-MD



DESIGN-MEDIA-OAK-12PCE-LG





INTRODUCING...

THE AMANTII SMART APP

SMART TECHNOLOGY, SMART CONTROL

With Amantii, the combination of functionality with applied smart technology creates the ultimate heating experience. Complete with WiFi connectivity, enhance the user experience with our Smart App that enables you to control your appliance from anywhere! Our app allows you to set tailored programs, schedule the exact date and time you wish to heat your room and select a desired temperature, design custom fire light effects, plus much more.

**It is important to note that the App's interface is subject to change*



AM-OUTDOOR-BROCH-US JAN 2024

Distributed By:

Amantii

Visit our online showrooms at:

www.amantii.com

Product updates, specifications and dimensions are subject to change. Please refer to the product manual to verify measurements and clearance requirements. All local building codes must be followed.